

FADINI
el abre verjas

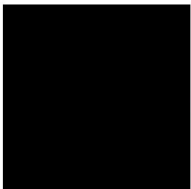

Puertas & Portones Automáticos, S.A. de C.V.
¡Nuestra pasión es la Solución!....

» OPERADOR ELECTROMECHANICO CORREDIZO DE CREMALLERA USO INTENSIVO MARCA FADINI MOD.NYOTA 115 EVO.

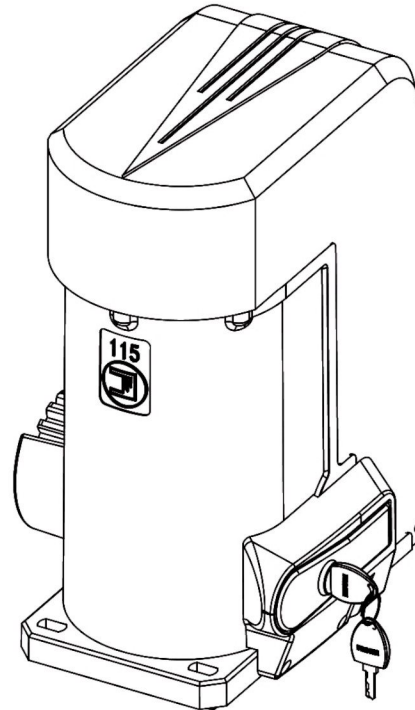
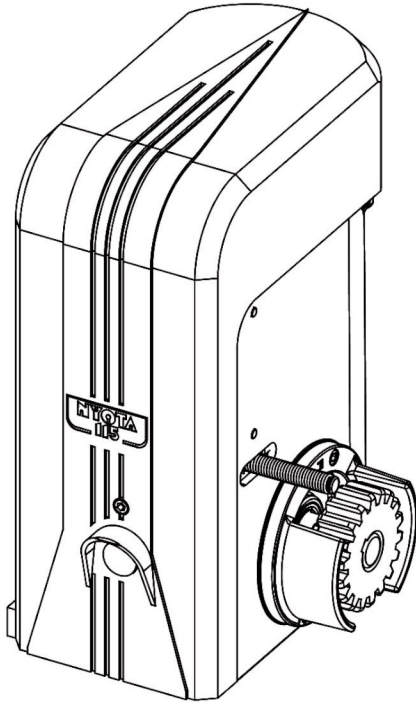

(229) 288-1552

portonesautomaticos@adsver.com.mx
portonesautomaticos@prodigy.net.mx









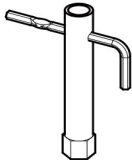

V05.21

(229) 927-5107, 167-8080, 167-8007, 151-7529.

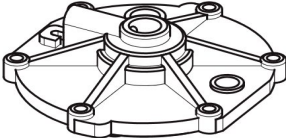

www.adsver.com.mx

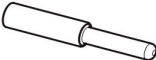

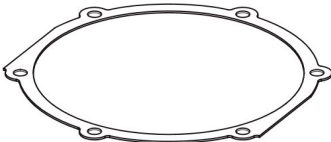
RIF. ARTICOLO	FIGURA	POSIZIONE	DENOMINAZIONE	QUANTITA'	CODICE D'ORDINE
11501		1 ●	Chiave registro frizione mod. 1	1	115121
11502		2 ●	Condotto passa cavi elettrici	1	115142
11503		3 ●	Ghiera di blocco cavi elettrici	1	115142
11504		4 ●	Collare per cavi elettrici	1	115142
11505		5 ●	Vite M6x25 TEI	8	115142
11506		6 ●	Coperchio motore elettrico	1	115142
11507		7 ●	Molla a compressione 0,7x8x24 spinotto di fermo	1	115142
11508		8 ●	Spinotto di fermo	1	115142
11509		9 ●	Spina elastica ø 3,5x18 zincata	1	115142
11510		10 ●	Guarnizione guarnital coperchio motore elettrico	1	115142



FADINI[®]
l'apricancello











Nyota 115 - Nyota 115 evo

■ solo per Nyota 115

● per Nyota 115 / Nyota 115 evo

SP.K17

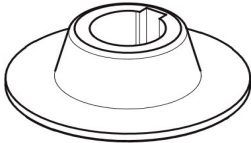
PEZZI DI RICAMBIO

11511		11 ●	Guaina ø 5x90 passa fili elettrici	1	11511
11512		12 ●	Guarnizione di tenuta 35-17-7	1	115130
11513		13 ■	Pattini freno	2	115130
11514		14 ●	Anello espansibile ø 40	1	11514
11515		15 ●	Cuscinetto radiale 6203-2RS	2	115501
11516		16 ●	Vite M8x30 TE	1	115511
11517		17 ●	Cartellino di taratura frizione	1	11517
11518		18 ●	Dado M8x6 • n° 2 pz. per Nyota 115 • n° 1 pz. per Nyota 115 evo		115511
11519		19 ●	Spinotto distanziale ø 6x151	1	115511
11520		20 ■	Ancora freno (non disponibile per spedizione)	1	
11521		21	Molla a compressione ancora freno 0,8x7,2x23 (non si usa più; riferimento art. 115120)	4	

Le immagini riportate in questo listino sono puramente indicative.



FADINI®
l'apricancello









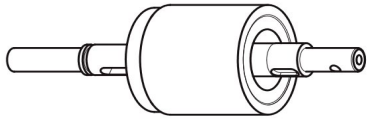

Nyota 115 - Nyota 115 evo

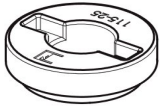
■ solo per Nyota 115

● per Nyota 115 / Nyota 115 evo

SP.K17

PEZZI DI RICAMBIO

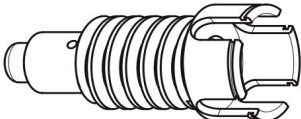
11522		22 ■	Rotore motore elettrico CV 0,5 - H 60 <i>(non disponibile per spedizione)</i>	1	
11523		23 ●	Chiavetta 8x8x40 collare frizione	1	115511
11524		24 ●	Collare spingi molle frizione mod. 25	1	115511
11525		25 ●	Molla a compressione 0,8x7,2x15 collare frizione	4	115511
11526		26 ●	Seeger E50	1	115511
11527		27 ●	Disco di trascinamento frizione mod. 28	6	115129
11528		28 ●	Disco dentato frizione in ottone mod. 29	3	115129
11529		29 ●	Fermo a forcella mod. 31	1	115129
11530		30 ●	Molla a tazza di compensazione ø 27,6 esterno x 17,3x0,35	1	115129
11531		31 ●	Boccola in bronzo per vite senza fine	2	115511
11532		32 ●	Vite senza fine mod. 33	1	115511



FADINI[®]
l'apricancello







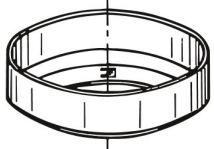
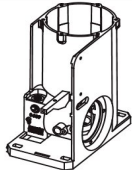

Nyota 115 - Nyota 115 evo

■ solo per Nyota 115

● per Nyota 115 / Nyota 115 evo

SP.K17

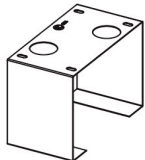
PEZZI DI RICAMBIO

11533		33 ■	Statore motore elettrico monofase CV 0,5 - H 60 <i>(non disponibile per spedizione)</i>	1	
11534		34	Calotta di protezione mod. 19 <i>(non si usa più)</i>	1	
11535		35 ■	Carcassa riduttore mod. 32 <i>(non disponibile per spedizione)</i>	1	
11536		36 ■	Tappo olio TAO 3/8"	1	115505
11537		37 ■	Guarnizione tappo olio	1	115505
11538		38 ●	Capocorda ad occhio	1	115510
11539		39 ●	Rondella ø 5 dentellata	1	115510
11540		40 ●	Vite M5x10 TCC	2	115510
11541		41 ●	Basamento di ancoraggio mod. 37	1	11541
11542		42 ●	Dado M8x8 basamento di ancoraggio	4	115121
11543		43 ●	Rondella ø 8 • n° 5 pz. per Nyota 115 • n° 4 pz. per Nyota 115 evo		115121

Le immagini riportate in questo listino sono puramente indicative.



FADINI®
l'apricancello







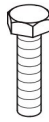

Nyota 115 - Nyota 115 evo

■ solo per Nyota 115

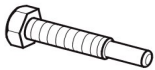
● per Nyota 115 / Nyota 115 evo

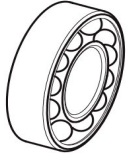



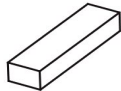
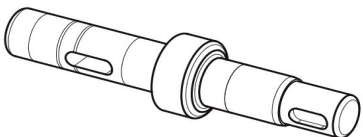



SP.K17

PEZZI DI RICAMBIO

11544		44 ●	Vite M8x35 TE di fissaggio basamento	4	115121
11545		45 ■	Cartellino d'istruzione blocco/sblocco (non si usa più)	1	
11546		46 ■	Vite M8x50 TE tornita (non si usa più)	1	
11547		47 ■	Anello di tenuta	1	115130
11548		48 ●	Guarnizione di tenuta 38-25-8	2	115130
11549		49 ●	Cuscinetto radiale 6205	2	115508
11550		50 ●	Seeger E25 • n° 2 pz. per Nyota 115 • n° 3 pz. per Nyota 115 evo		115508
11551		51 ■	Disco di trascinamento mod. 400/5 (non disponibile per spedizione)	1	
11552		52 ●	Corona dentata Z = 32 modulo 2,5 in bronzo	1	115508
11553		53 ■	Chiavetta 12x8x47 (non disponibile per spedizione)	1	
11554		54 ■	Albero di trascinamento (non disponibile per spedizione)	1	

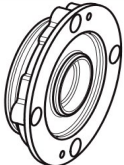
Le immagini riportate in questo listino sono puramente indicative.

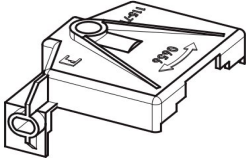
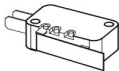
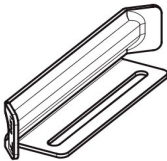

11555		55 ●	Chiavetta 7x8x20 • n° 2 pz. per Nyota 115 • n° 1 pz. per Nyota 115 evo		115508
11556		56 ●	Anello espansibile ø 52 esterno	1	115508
11557		57	Guarnizione OR 4337 <i>(non si usa più; riferimento art. 115116)</i>	1	
11558		58	Guarnizione guarnital flangia ingranaggio <i>(non si usa più; riferimento art. 115116)</i>	1	
11559		59 ●	Flangia supporto albero ingranaggio mod. 50 • VECCHIO dis. 0997 • NUOVO dis. 4226	1	115508
11560		60 ●	Vite M8x20 TEI per flangia di supporto	4	115508
11561		61 ●	Ingranaggio Z18 M4	1	11561
11562		62 ●	Grano di fermo M8x16 a punta	3	115508
11563		63 ■	Coperchio finecorsa mod. 71	1	115126
11564		64 ■	Microinterruttore	2	11564
11565		65 ■	Asola di finecorsa	2	115121



FADINI[®]
l'apricancello









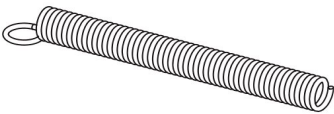

Nyota 115 - Nyota 115 evo

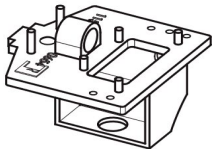
■ solo per Nyota 115

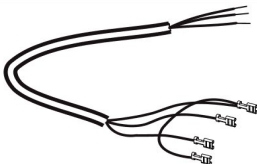
● per Nyota 115 / Nyota 115 evo

SP.K17

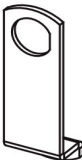
PEZZI DI RICAMBIO

11566		66 ■	Asta flessibile inox	1	115126
11567		67	Rotella con gambo finecorsa (sostituito con codice d'ordine 115126)	1	
11568		68 ■	Supporto micro mod. 69	1	115126
11569		69	Filo elettrico da 0,75x100 (non si usa più)	1	
11570		70 ■	Cavo elettrico per finecorsa	1	115126
11571		71 ■	Vite speciale M5x4	1	115119
11572		72 ■	Levetta A/O	1	115119
11573		73 ■	Dado esagonale 20x1	1	115119
11574		74 ■	Staffa di fermo cofano mod. 59	1	115119
11575		75 ■	Cofano mod. 60	1	11575
11576		76 ■	Serratura 1052	1	115119



11577		77 ■	Tappo foro serratura cofano mod. 63	1	11577
11578		78 ■	Chiavi serratura	2	115119
11579		79 ■	Inserto di protezione sblocco mod. 99	1	11579
11580		80 ■	Adesivo d'istruzione "non capovolgere" <i>(non si usa più)</i>	1	
11581		81 ■	Bollino adesivo Elpro 12 <i>(non si usa più)</i>	1	
11582		82 ●	Vite autofilettante 4,2x13 TS • n° 4 pz. per Nyota 115 • n° 4 pz. per Nyota 115 evo		115143
11583		83 ■	Vite autofilettante 3,5x13 TC <i>(non si usa più)</i>	1	
11584		84 ■	Coperchio scatto interruttore mod. 77 <i>(non si usa più)</i>	1	
11585		85 ■	Molla a compressione 1x6,7x41 scatto interruttore <i>(non si usa più)</i>	1	
11586		86 ■	Bilanciere mod. 82 <i>(non si usa più)</i>	1	
11587		87 ■	Dado esagonale 12x1 <i>(non si usa più)</i>	1	



FADINI®
l'apricancello







Nyota 115 - Nyota 115 evo

■ solo per Nyota 115

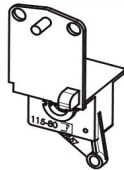
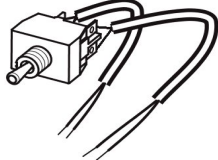
● per Nyota 115 / Nyota 115 evo

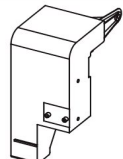
SP.K17

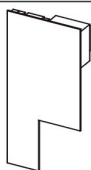
PEZZI DI RICAMBIO

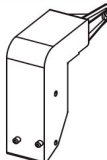
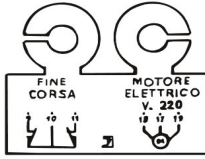
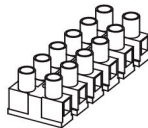
11588		88	Rondella con dente $\varnothing 12$ <i>(non si usa più)</i>	1	
11589		89	Supporto interruttore elettrico mod. 80 <i>(non si usa più)</i>	1	
11590		90	Interruttore elettrico <i>(non si usa più)</i>	1	
11591		91	Cartellino d'istruzione alimentazione 230 V <i>(non si usa più)</i>	1	
11592		92	Contenitore scheda programmatore mod. 92	1	1159295
11593		93	Vite M6x14 TEI	4	1159295
11594		94	Scheda programmatore elettronico Elpro 12 Plus	1	
11595		95	Coperchio contenitore scheda mod. 94	1	1159295
11596		96	Contenitore cavi elettrici mod. 83	1	115143
11597		97	Cartellino collegamenti elettrici <i>(non si usa più)</i>	1	
11598		98	Morsettiera a 6 posti	1	11598



FADINI®
l'apricancello

Nyota 115 - Nyota 115 evo

■ solo per Nyota 115

● per Nyota 115 / Nyota 115 evo

SP.K17

PEZZI DI RICAMBIO

11599		99 ■	Supporto morsettieria mod. 72	1	11599
115100		100 ●	Coperchio contenitore cavi elettrici mod. 86	1	115143
115101		101 ●	Cartellino adesivo dati tecnici motore elettrico	1	115143
115102		102 ●	Libretto d'istruzione multilingua schema elettrico Elpro 12 Plus / Elpro 12 evo	1	115102
115103		103 ●	Condensatore da 30 µF	1	115103
115104		104 ●	Microinterruttore con cavo elettrico	1	115104
115105		105 ●	Cartellino adesivo "contatto di sicurezza"	1	115105
115106		106 ■	Rotore motore elettrico CV 1,0 - H 80 <i>(non disponibile per spedizione)</i>	1	
115107		107 ■	Statore motore elettrico monofase CV 1,0 - H 80 <i>(non disponibile per spedizione)</i>	1	
115108		108	Tappo foro chiave sblocco mod. 64 <i>(non si usa più)</i>	1	
115109		109 ●	Olio "Oil Fadini" per motoriduttore, fornito in taniche da 2 litri	1	115109











FADINI[®]
l'apricancello

Nyota 115 - Nyota 115 evo

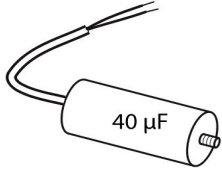
■ solo per Nyota 115
● per Nyota 115 / Nyota 115 evo

SP.K17

PEZZI DI RICAMBIO

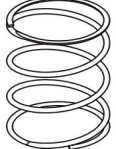
115110		110 ■	Morsetto ad un posto	1	115110
115111		111 ●	Passacavo a 3 fori per scatola programmatore	1	115111
115112		112 ■	Condensatore da 40 µF per motori da CV 1,0 monofase	1	115112
115113		113 ■	Puntale per molla finecorsa	1	115126
115114		114 ●	Copri ingranaggio	1	115114
115115		115	Vite M6x14 TEI <i>(non si usa più; riferimento art. 11593)</i>	2	
115116		116 ●	Guarnizione OR 2300 per flangia supporto albero ingranaggio	1	115130
115117		117 ●	Sfera ø 8,73 per vite senza fine	1	115511
		118			
		119			
115120		120 ■	Molla a compressione per freno motore <i>(non disponibile per spedizione)</i>	1	



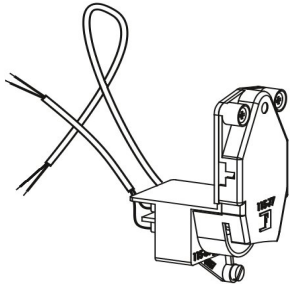
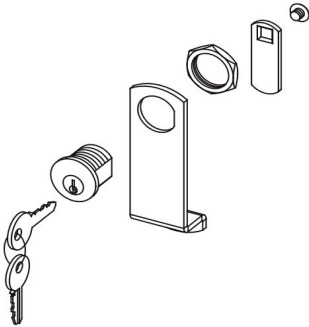
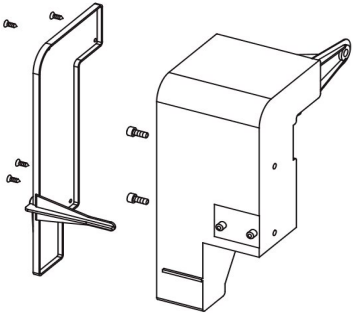
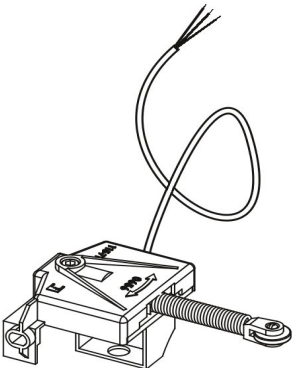

RIF. ARTICOLO	FIGURA	DENOMINAZIONE	CODICE D'ORDINE
115118		<p>Interruttore di linea completo di art: 82-83-84-85-86-87-88-89-90</p> <p>■ <i>(non disponibile per spedizione)</i></p>	
115119		<p>Serratura con staffa di fermo completa di art: 71-72-73-74-76-78</p> <p>■</p>	115119
1159295		<p>Contenitore scheda programmatore elettronico, completo di art: 82-92-93-95</p> <p>●</p>	1159295
1156370		<p>Fin corsa completo di art: 5-63-64-66-67-68-70</p> <p>■ <i>(sostituito con codice d'ordine 115126)</i></p>	115126



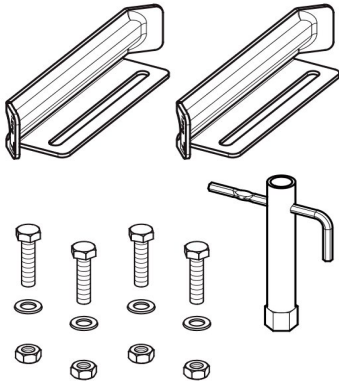
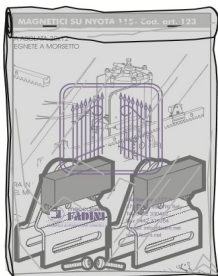
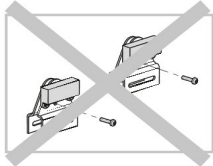
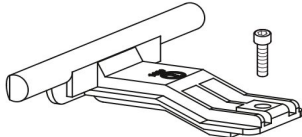
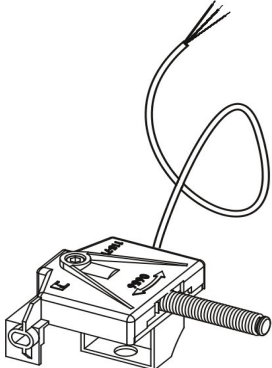

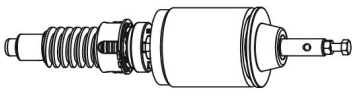
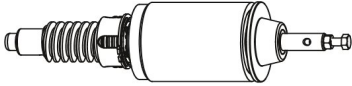
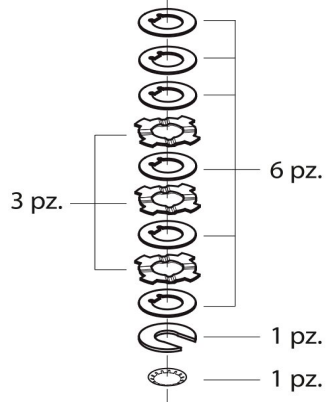

Le immagini riportate in questo listino sono puramente indicative.

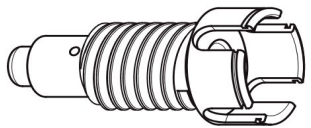

RIF. ARTICOLO	FIGURA	DENOMINAZIONE	CODICE D'ORDINE
115121		Confezione asole di finecorsa, bulloni, rondelle, dadi e chiave (art: 1-42-43-44-65) ■	115121
115122		Sacchetto con magneti, supporti, viti e foglio d'istruzioni ■ (articolo esaurito)	
115125	 (articolo esaurito) 	Finecorsa elettromagnetico con vite ■	115125
115126		Finecorsa con puntale, completo di art: 5-63-66-68-70-113 ■	115126

RIF. ARTICOLO	FIGURA	DENOMINAZIONE	CODICE D'ORDINE
115127		<p>Indotto motore elettrico CV 0,5 completo di art: 15-16-18-19-20-22-23-24-25-26-27-28-29-30-31-32-55-117-120</p> <p>■ (non disponibile per spedizione)</p>	
115128		<p>Indotto motore elettrico CV 1,0 completo di art: 15-16-18-19-20-23-24-25-26-27-28-29-30-31-32-55-106-117-120</p> <p>■ (non disponibile per spedizione)</p>	
115129		<p>Kit dischi frizione (Nyota 115 - 0,5 CV) per un indotto, completo di art: 27-28-29-30</p> <p>●</p>	115129
115130		<p>Confezione serie guarnizioni, completa di art: 10-12-13-47-48-116-415</p> <p>●</p>	115130



115131		131 ■	Statore (8 poli) 3 fili elettrici 700 giri/min. - CV 0,5 monofase Rif. Dis. 3345 (non disponibile per spedizione)	1	
115132		132 ■	Statore (8 poli) 3+3 fili elettrici 700 giri/min. - CV 0,5 trifase Rif. Dis. 3352 (non disponibile per spedizione)	1	
115133		133 ■	Rotore monofase/trifase - 700 giri/min. Rif. Dis. 3344 (non disponibile per spedizione)	1	
115134		134 ●	Vite senza fine a 3 principi con sede "disco dentato frizione"	1	115339
115135		135 ●	Corona dentata a 3 principi Z = 42 in bronzo	1	115135
115136		136 ■	Statore motore elettrico trifase CV 0,5 - H 60 (non disponibile per spedizione)	1	
115137		137 ■	Statore motore elettrico trifase CV 1,0 - H 80 (non disponibile per spedizione)	1	
		138			
		139			
		140			
		141			

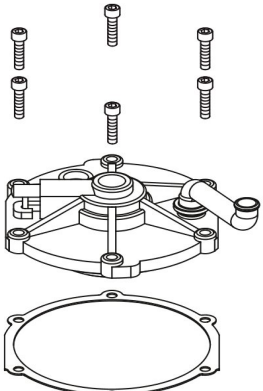
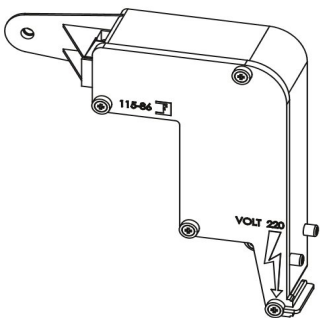
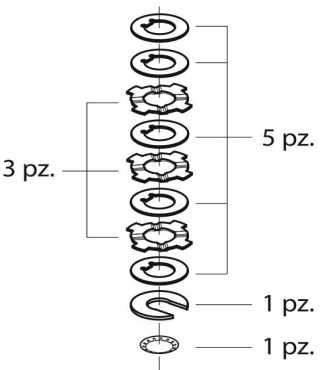
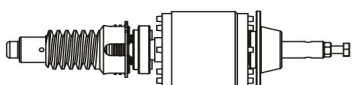

RIF. ARTICOLO	FIGURA	DENOMINAZIONE	CODICE D'ORDINE
115142		<p>Coperchio motore elettrico completo di art: 2-3-4-5-6-7-8-9-10-12-13</p> <p>●</p>	115142
115143		<p>Contenitore cavi elettrici completo di art: 82-93-96-100-101-450-451</p> <p>▲</p>	115143
115144		<p>Kit dischi frizione (Nyota 115 - 1,0 CV) per un indotto, completo di art: 27-28-29-30</p> <p>●</p>	115144
115145		<p>Indotto motore elettrico a 700 giri/min, completo di art: 15-16-18-19-20-23-24-25-26-27-28-29-30-31-32-55-117-120-133</p> <p>■</p> <p>(non disponibile per spedizione)</p>	

Le immagini riportate in questo listino sono puramente indicative.









FADINI[®]
l'apricancello

Nyota 115 - Nyota 115 evo

● per Nyota 115 / Nyota 115 evo
▲ solo per Nyota 115 evo

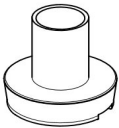
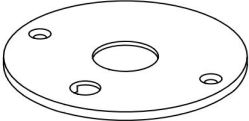
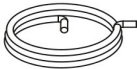
SP.K17

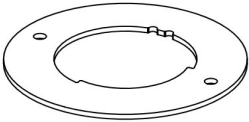
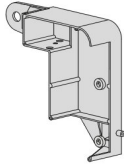
PEZZI DI RICAMBIO

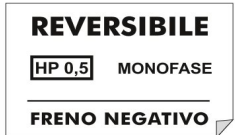





115308		● 308	Vite M5x20 TEI zincata	2	115338
115309		● 309	Cassa con bobina elettrica	1	115338
115310		● 310	Morsetto a mantello 2,5	1	115338
115311		● 311	Distanziale di guida con sede molla in ottone	1	115339
115312		● 312	Ancora superiore freno tipo "Fe"	1	115339
115313		● 313	Molla a trazione conica	1	115339
115314		● 314	Borchia da rivettare	2	115339
115315		● 315	Disco secondario fermo molla in "Fe"	1	115339
115319		● 319	Contenitore cavi elettrici con sede di attacco scatola per scheda "freno negativo" <i>(sostituito con codice d'ordine 115143)</i>	1	
115321		▲ 321	Etichetta autoadesiva " FRENE / ELPRO 37 FN - 45 46 NEGA "	1	115338
115322		● 322	Targa autoadesiva di identificazione - monofase -	1	115322

Le immagini riportate in questo listino sono puramente indicative.





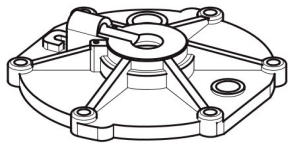
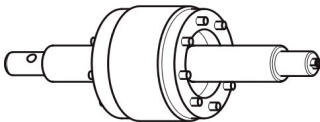
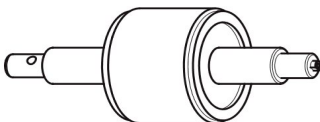
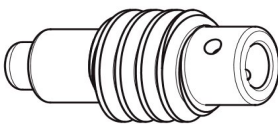

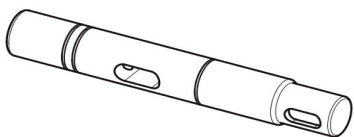

115324		324 ▲	Distanziale fondello motore freno negativo (Nyota 115 evo)	1	115338
115325		325 ▲	Coperchio motore elettrico per versione reversibile (Nyota 115 evo)	1	115338
115326		326 ▲	Rotore motore elettrico CV 0,5 - H60 per versione reversibile (Nyota 115 evo)	1	115339



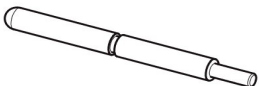
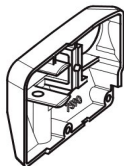
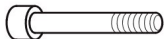





115401		401	Vite M4x10 TSC	1	115500
115402		402	Magnete a 12 polarità	1	115500
115403		403	Vite 2,9x22 autofilettante	2	115509
115404		404	Rilevatore magnetico encoder	1	115509
115405		405	Coperchio motore elettrico	1	115500
115406		406	Rotore motore elettrico CV 0,5 - H40	1	115501
115407		407	Rotore motore elettrico CV 1,0 - H60	1	115502
115408		408	Vite senza fine - modulo 2,5	1	115501
115409		409	Spina elastica \varnothing 6x30	1	115501
115410		410	Campana protezione chiavetta	1	115508
115411		411	Albero di trascinamento	1	115508

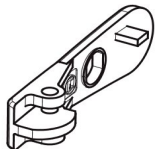

115412		412 ▲	Chiavetta 10x45 di sblocco	1	115508
115413		413 ▲	Piastrina sagomata dello sblocco	1	115508
115414		414 ▲	Molla dello sblocco 1x8,3x30,5	1	115508
115415	0	415 ▲	Guarnizione OR 2018	1	115508
115416		416 ▲	Spina dello sblocco manuale	1	115508
115417		417 ▲	Supporto maniglia di sblocco	1	115503
115418		418 ▲	Vite M8x45 TEI	1	115503
115419		419 ▲	Vite M5x16 TEI	1	115503
115420		420 ▲	Seeger da 7	1	115503
115421		421 ▲	Levetta da 35 mm	1	115503
115422		422 ▲	Dado stretto M19 x p1,2	1	115503

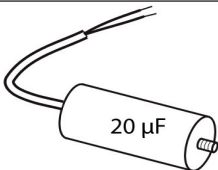
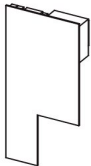
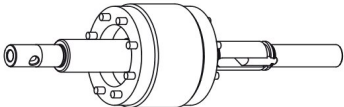
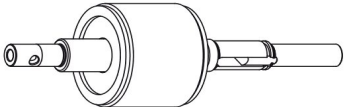
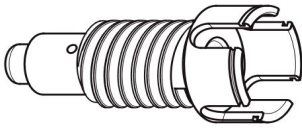

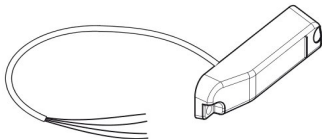
115423		423 ▲	Maniglia di sblocco manuale	1	115503
115424		424 ▲	Molla inox di aiuto maniglia di sblocco	1	115503
115425		425 ▲	Serratura WA7001 con cilindro e cassa	1	115503
115426		426 ▲	Chiavi cifrate WA7001	2	115503
115427		427 ▲	Condensatore da 20 µF	1	115427
115428		428 ▲	Scheda programmatore elettronico Elpro 12 evo	1	
115429		429 ▲	Rotore motore elettrico 0,5 CV - H40 frizione meccanica	1	115511
115430		430 ▲	Rotore motore elettrico 1,0 CV - H60 frizione meccanica	1	115512
115431		431 ▲	Vite senza fine modulo 2 - 60 Hz	1	115431
115432		432 ▲	Corona dentata Z = 38 modulo 2 in bronzo	1	115432
115433		433 ▲	Finecorsa magnetico cavo corto	1	115433











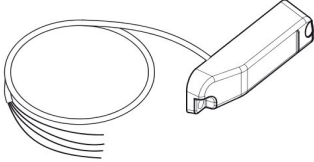

FADINI®
l'apricancello

Nyota 115 - Nyota 115 evo

▲ solo per Nyota 115 evo

SP.K17

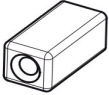
PEZZI DI RICAMBIO

115434		434 ▲	Finecorsa magnetico cavo lungo	1	115434
115435		435 ▲	Lama fermo statore	2	115510
115436		436 ▲	Statore motore elettrico monofase 0,5 CV - H 40	1	115436
115437		437 ▲	Statore motore elettrico trifase 0,5 CV - H 40	1	115437
115438		438 ▲	Statore motore elettrico monofase 0,5 CV - H 40 - 60 Hz	1	115438
115439		439 ▲	Statore motore elettrico monofase 0,5 CV - H 40 - 700 rpm	1	115439
115440		440 ▲	Statore motore elettrico trifase 0,5 CV - H 40 - 700 rpm	1	115440
115441		441 ▲	Statore motore elettrico monofase 1,0 CV - H 60	1	115441
115442		442 ▲	Statore motore elettrico trifase 1,0 CV - H 60	1	115442
115443		443 ▲	Distanziale fissaggio cofano	1	115443
115444		444 ▲	Adesivo identificativo Nyota monofase Elpro 12 evo - 0,5 CV	1	115444

Le immagini riportate in questo listino sono puramente indicative.



115445		445 ▲	Adesivo identificativo Nyota monofase Elpro 12 evo - 1,0 CV	1	115445
115446		446 ▲	Adesivo identificativo Nyota trifase 0,5 CV	1	115446
115447		447 ▲	Adesivo identificativo Nyota trifase 1,0 CV	1	115447
115448		448 ▲	Adesivo identificativo Nyota monofase 0,5 CV	1	115448
115449		449 ▲	Adesivo identificativo Nyota monofase 1,0 CV	1	115449
115450		450 ▲	Morsettiera a 7 posti	1	115143
115451		451 ▲	Cartellino collegamenti elettrici	1	115143
115452		452 ▲	Carcassa riduttore	1	115510
115453		453 ▲	Cofano	1	115453
		454 ▲			
		455 ▲			

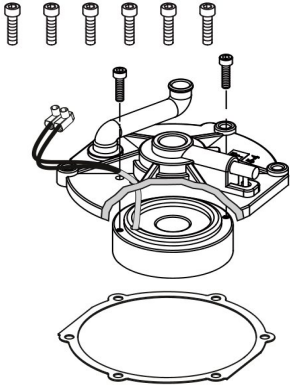
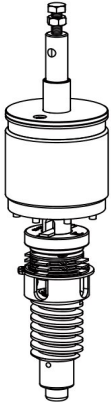

RIF. ARTICOLO	FIGURA	DENOMINAZIONE	CODICE D'ORDINE
115338		<p>Coperchio motore elettrico per versione reversibile (Nyota 115 evo), completo di art: 2-3-4-7-8-9-10-12-15-308-309-310-321-324-325-327</p> <p>▲</p>	115338
115339		<p>Indotto motore elettrico CV 0,5 reversibile (Nyota 115 evo), completo di art: 16-17-18-19-23-24-25-26-27-28-29-30-31-117-134-311-312-313-314-315-326</p> <p>▲</p>	115339

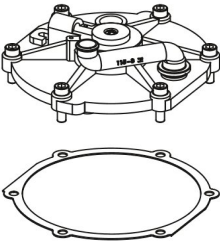
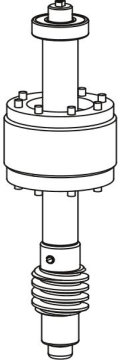
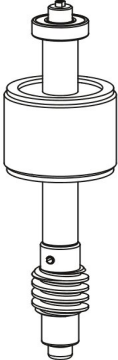
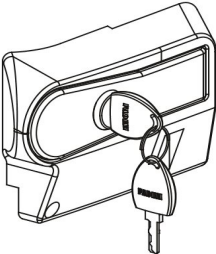

RIF. ARTICOLO	FIGURA	DENOMINAZIONE	CODICE D'ORDINE
115500		<p>Coperchio motore elettrico completo di art: 2-3-4-5-10-12-401-402-405</p> <p>▲</p>	115500
115501		<p>Indotto motore elettrico (per encoder) CV 0,5 completo di art: 15-406-408-409</p> <p>▲</p>	115501
115502		<p>Indotto motore elettrico (per encoder) CV 1,0 completo di art: 15-407-408-409</p> <p>▲</p>	115502
115503		<p>Maniglia di sblocco completa di art: 417-418-419-420-421-422-423-424-425-426</p> <p>▲</p>	115503

Le immagini riportate in questo listino sono puramente indicative.

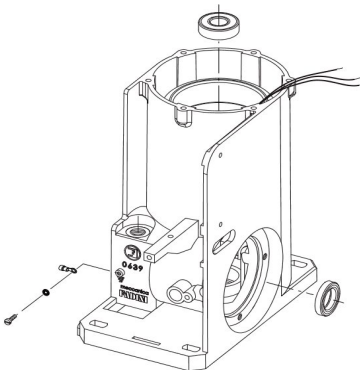
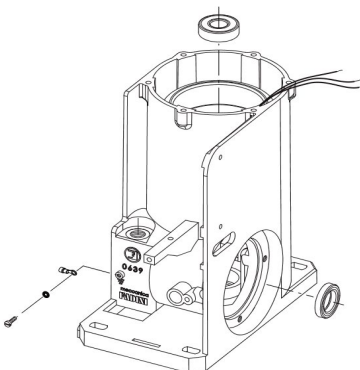

RIF. ARTICOLO	FIGURA	DENOMINAZIONE	CODICE D'ORDINE
115505		<p>Tappo olio TAO 3/8" con guarnizione, completo di art: 36-37</p>	115505
115506		<p>Carcassa riduttore mod. 32 per CV 0,5 monofase completa di art: 15-33-35-38-39-40-48</p> <p>■ (non disponibile per spedizione)</p>	
115507		<p>Carcassa riduttore mod. 32 per CV 1,0 monofase completa di art: 15-35-38-39-40-48-107</p> <p>■ (non disponibile per spedizione)</p>	

Le immagini riportate in questo listino sono puramente indicative.

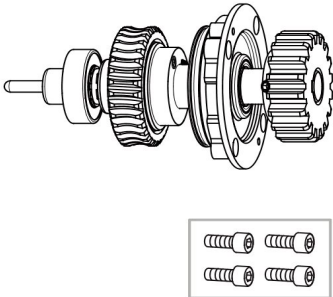
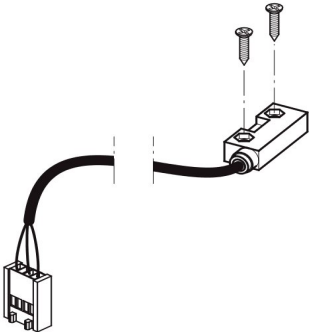
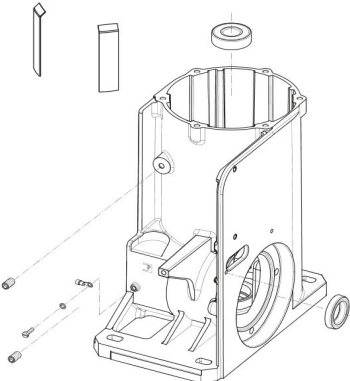
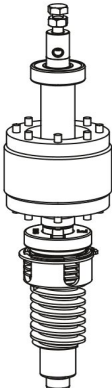

RIF. ARTICOLO	FIGURA	DENOMINAZIONE	CODICE D'ORDINE
115508	 <p>n° 4 pz. art. 60 ▲</p>	<p>Albero di trascinamento completo di art: 48-49-50-52-55-56-59-60-61-62-116-410-411-412-413-414-415-416</p>	115508
115509		<p>Rilevatore magnetico encoder con viti, completo di art: 403-404 ▲</p>	115509
115510		<p>Carcassa riduttore completa di art: 15-38-39-40-48-62-435-452 ▲</p>	115510
115511		<p>Indotto motore elettrico (con frizione meccanica) CV 0,5 completo di art: 15-16-18-19-23-24-25-26-27-28-29-30-31-32-55-117-429 ▲</p>	115511

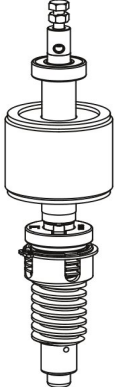
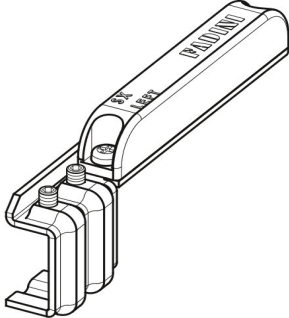
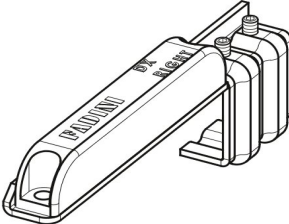
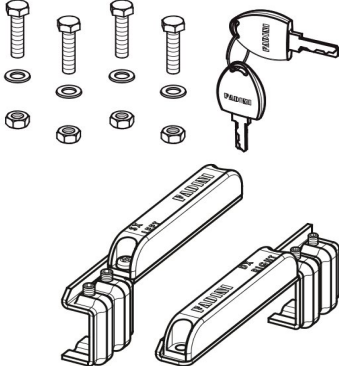

RIF. ARTICOLO	FIGURA	DENOMINAZIONE	CODICE D'ORDINE
115512		Indotto motore elettrico (con frizione meccanica) CV 1,0 completo di art: 15-16-18-19-23-24-25-26-27-28-29-30-31-32-55-117-430	115512
115513		Staffa finecorsa magnetico SX completa <i>(non si usa più; riferimento art. 115515)</i>	
115514		Staffa finecorsa magnetico DX completa <i>(non si usa più; riferimento art. 115515)</i>	
115515		Staffe finecorsa magnetico, complete di art: 42-43-44-426 e cod. 115513-115514	115515

Le immagini riportate in questo listino sono puramente indicative.



Puertas & Portones Automáticos, S.A. de C.V.
¡Nuestra pasión es la Solución!....

» OPERADOR ELECTROMECHANICO CORREDIZO DE CREMALLERA
USO INTENSIVO MARCA FADINI MOD.NYOTA 115 EVO.



Puertas & Portones Automáticos, S.A. de C.V.
¡Nuestra pasión es la Solución!....

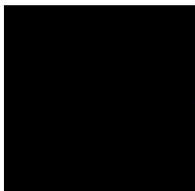

(229) 288-1552

portonesautomaticos@adsver.com.mx
portonesautomaticos@prodigy.net.mx



RESIDENCIAL



COMERCIAL



INDUSTRIAL



V04.21